



Silver Series

7th Generation

Product Information Guide



Speakers that speak to you

Our most popular loudspeaker range gets better than ever with a brand new design, featuring all our new acoustic innovations as a result of our continued commitment to research and development.



Silver Series 7G Key Features

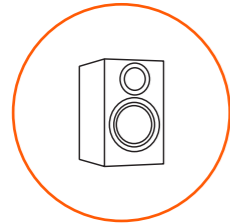

Superior in sound and build quality



Designed for your home, with clean lines to suit both classic and contemporary home décor



Performance led – intricately engineered to optimise the audio experience



New RST II bass/mid driver design with Damped Concentric Mode technology

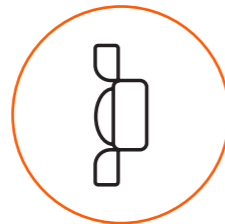

New C-CAM Tweeter design with optimised Uniform Dispersion Waveguide

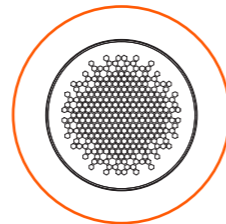

The Monitor Audio family aesthetic with acoustically transparent hexagonal dispersion pattern on the tweeter plate

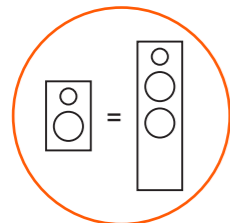

Floorstander-like bass extension for the new Bookshelf speakers



New Silver AMS Dolby Atmos® enabled speaker to add a new dimension to movie soundtracks



New cabinet design with new real-wood veneer finishes

1" (25mm) C-CAM Gold Dome Tweeter featuring New Uniform Dispersion (UD) Waveguide II
An evolution of the Monitor Audio signature C-CAM Gold Dome tweeter featuring an optimised version of our UD Waveguide for more lifelike sound.

New 3" RST II Mid-Range Driver
Building on the technology from Gold Series combined with our new RST II geometry smooth and low distortion mid-range.

New RST II Mid/Bass Drivers
Mixing our Damped Concentric Mode technology with a new hexagonal dimpled structure to optimise performance.

High Quality Contemporary Finishes
Silver Series 7G uses a new crisp aesthetic with luxurious real-wood veneer, available in contemporary finishes.

New Outrigger Feet
The new Silver Series 7G outrigger feet improve stability, featuring a locking foot design for use with carpet or hard floors.

New Monitor Audio Branding
Silver Series 7G is the first Monitor Audio product to feature our new updated logo.

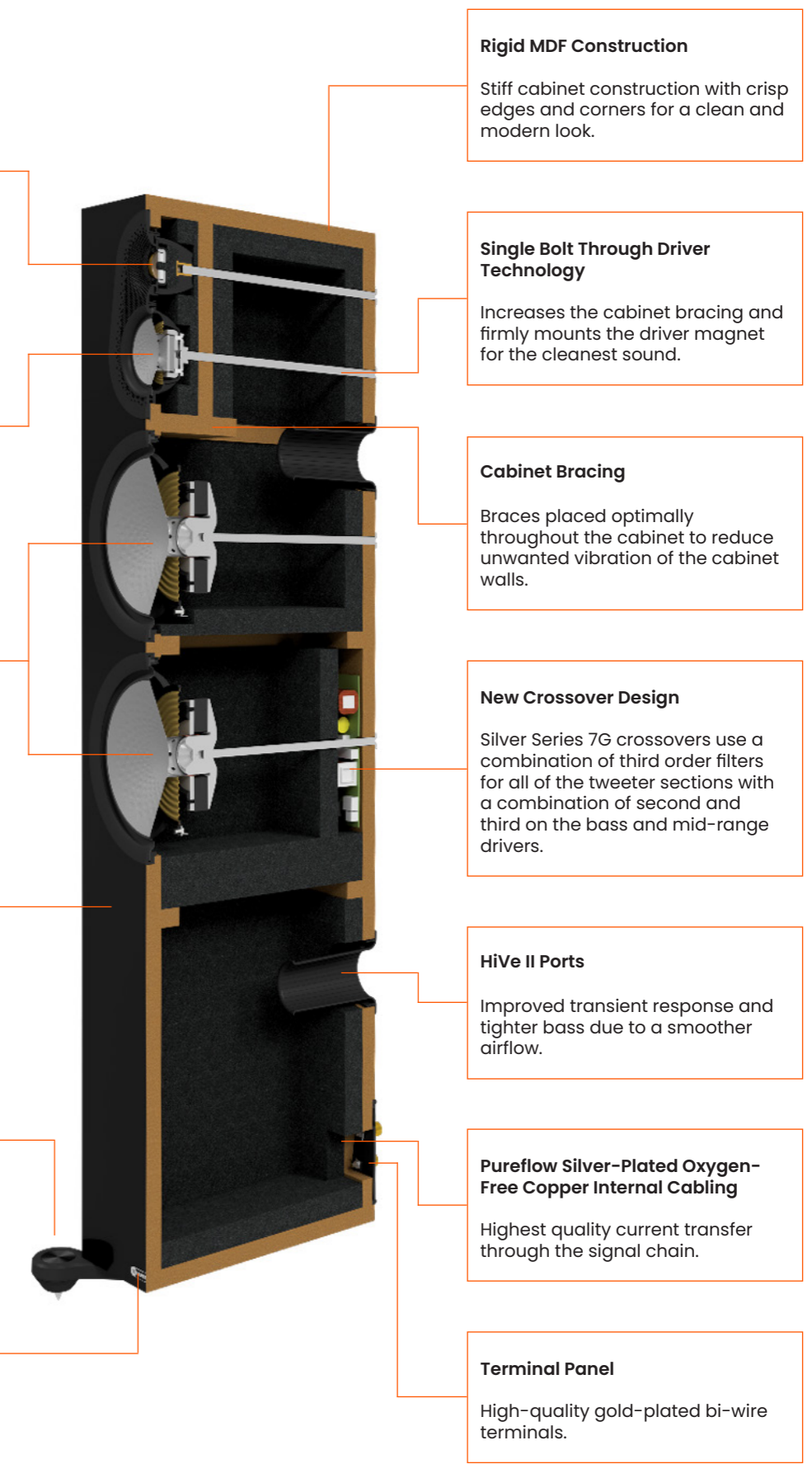

Rigid MDF Construction
Stiff cabinet construction with crisp edges and corners for a clean and modern look.

Single Bolt Through Driver Technology
Increases the cabinet bracing and firmly mounts the driver magnet for the cleanest sound.

Cabinet Bracing
Braces placed optimally throughout the cabinet to reduce unwanted vibration of the cabinet walls.

New Crossover Design
Silver Series 7G crossovers use a combination of third order filters for all of the tweeter sections with a combination of second and third on the bass and mid-range drivers.

HiVe II Ports
Improved transient response and tighter bass due to a smoother airflow.

Pureflow Silver-Plated Oxygen-Free Copper Internal Cabling
Highest quality current transfer through the signal chain.

Terminal Panel
High-quality gold-plated bi-wire terminals.

New RST II driver design

Our new Rigid Surface Technology (RST) II pattern has been evolved to give a more rigid profile with a new hexagonal dimpled structure, derived from Gold 5G's RDT II development.

RST II is more than just a pattern on the cone. It represents a collection of technologies, a new cone geometry profile that improves the performance of the driver at higher frequencies, an improvement to C-CAM technology and a glimpse at the underlying design elements that are not usually visible.



New RST II mid-range driver

Vocals have never sounded this clear

Building on the work conducted for the Gold 5G range Monitor Audio has developed a new mid-range for the Silver 7G range. The mid-range follows the same design aims, to improve directivity through the use of a compact design and to maximise the bandwidth of the driver to allow a smooth crossover with the tweeter.

Together, all this technology can be seen as RST II that delivers smooth and low distortion mid-range.

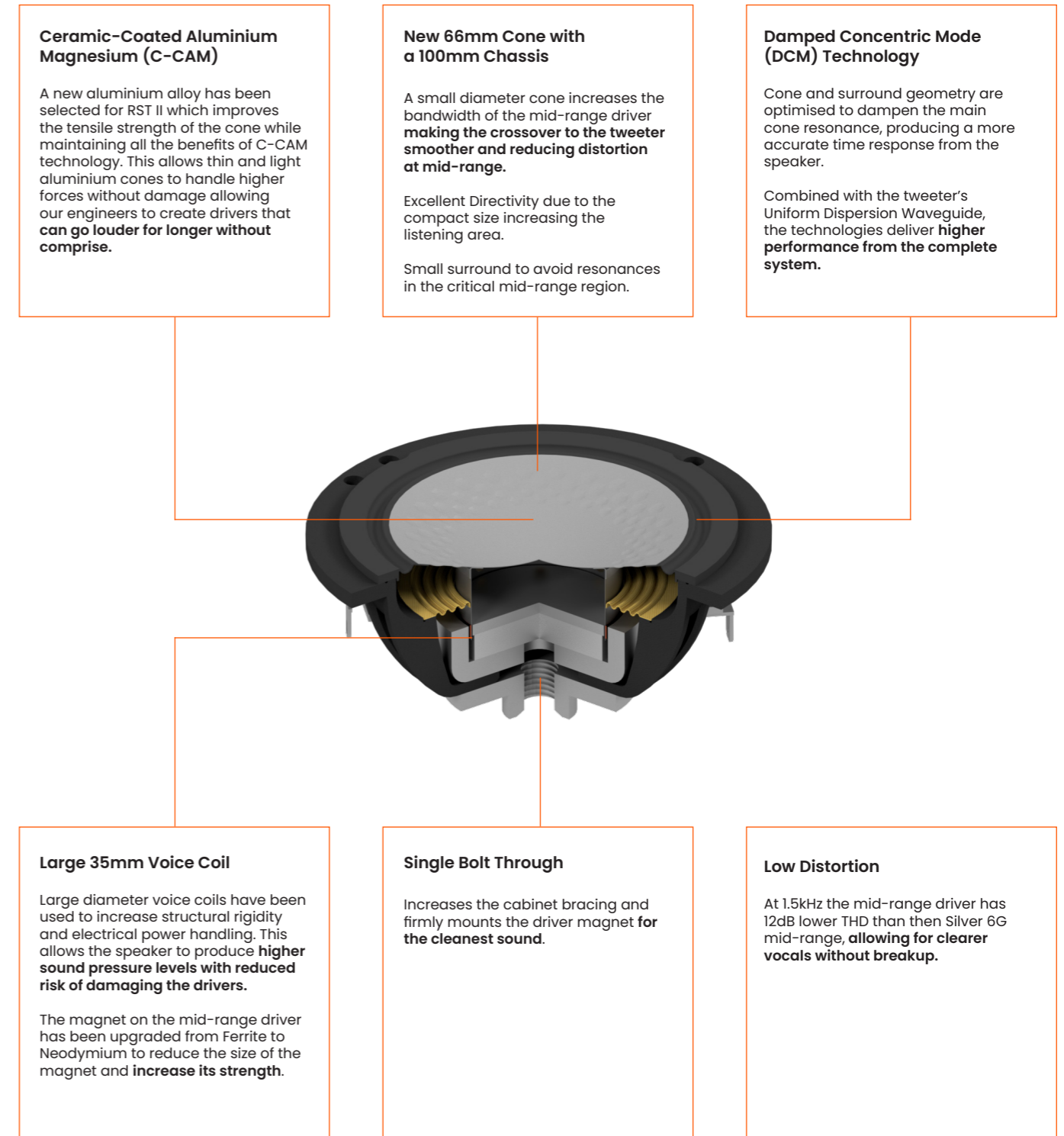

New RST II mid/bass driver

Turn it up without the break up

Ceramic-Coated Aluminium Magnesium (C-CAM)

A new aluminium alloy has been selected for RST II which improves the tensile strength of the cone while maintaining all the benefits of C-CAM technology. This allows thin and light aluminium cones to handle higher forces without damage allowing our engineers to create drivers that **can go louder for longer without compromise.**

Damped Concentric Mode (DCM) Technology

New cone geometry compared with Bronze 6G.
Cone and surround geometry are optimised to dampen the main cone resonance, producing a more accurate time response from the speaker.
Combined with the tweeter's Uniform Dispersion Waveguide, **the technologies deliver higher performance from the full system.**

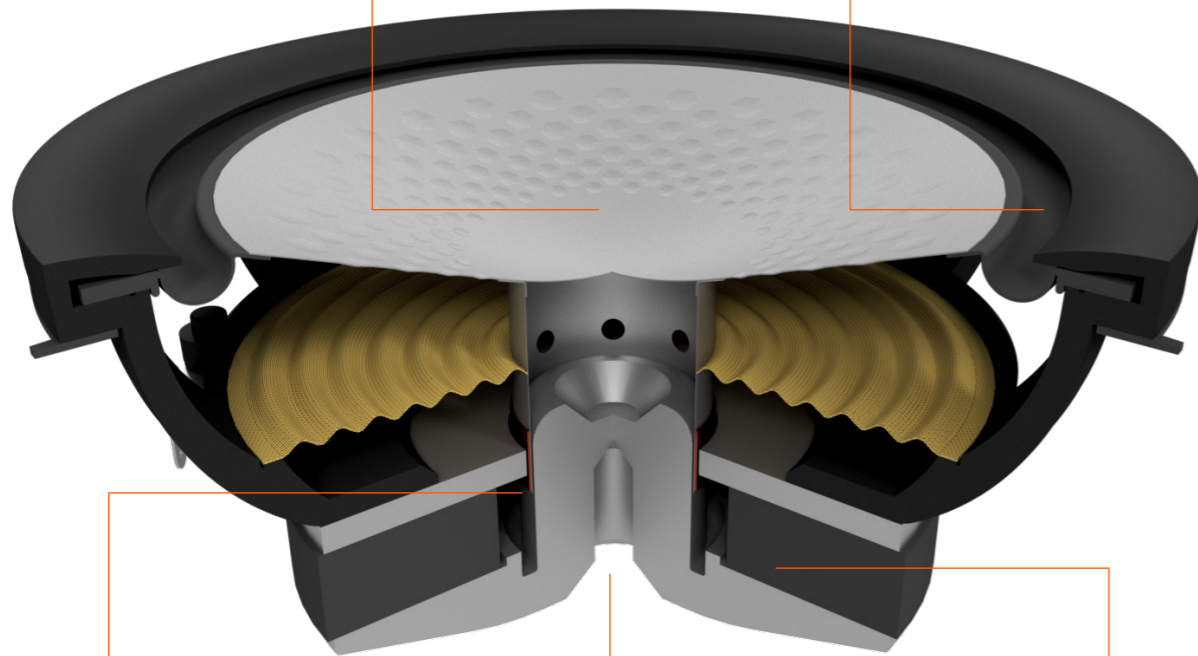

Large Diameter Voice Coil

5 1/4" (134mm) increase voice coil diameter from 25mm in 6G to 28.5mm in 7G.

8in remains the same diameter as 6G.

Large voice coil diameter allows **high power handling with reduced risk of damaging the drivers**

Single Bolt Through

Increases the cabinet bracing and firmly mounts the driver magnet **for the cleanest sound.**

Large Motor Unit

All 7G drivers have large magnet structures which offer high levels of electrical damping for controlled punchy bass.

Bass notes start and stop with exceptional timing.

New C-CAM tweeter design

All the details that you never heard before.

The new C-CAM tweeter features a completely new magnet structure, rear chamber design and surround, as well as taking our Uniform Dispersion Waveguide technology and further refining it.

Acoustically Transparent Diffusion / Hexagonal Pattern Grille

The new grille design further refines the design with the diffusion pattern optimised such that **it does not interfere with the tweeter's waveguide function.**

Ceramic-Coated Aluminium Magnesium (C-CAM) Gold Dome

The strong but lightweight 25mm C-CAM diaphragm ensures that the diaphragm acts as a rigid piston through the pass band, and the **breakup frequency is pushed well above the audible range.**

Vented Surround

The rear side of the surround is vented around the outside of the magnet structure and into the main chamber to **reduce a build up of energy.** (image below is without surround)

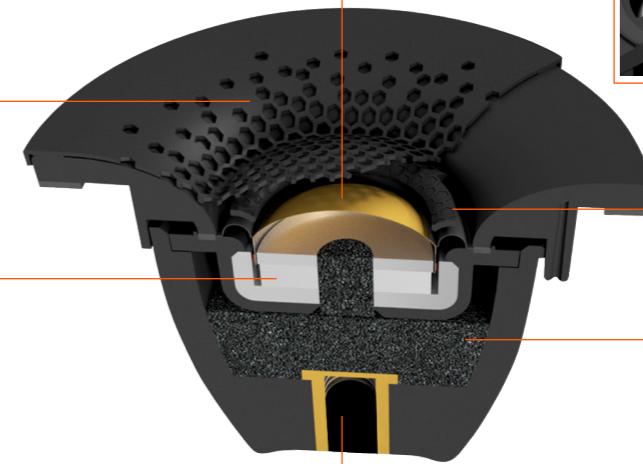
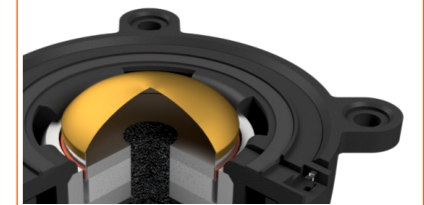

Motor Structure

New ring magnet structure with increased linear excursion.

Single Bolt Through

Securely mounted tweeter using single bolt through technology **ensures the tweeter chassis cannot resonate.**

Surround Material

Improved surround damping smooths the high frequency performance.

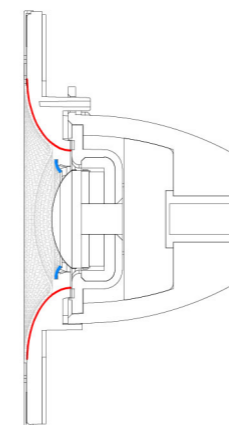

Uniform Dispersion (UD) Waveguide II

Uniform Dispersion Waveguide produces (1) even dispersion characteristics, (2) improved time alignment so the wave fronts from both tweeter and drivers will reach the listener simultaneously, and (3) lower crossover frequency for wider directivity.

Building on the UD Waveguide, this new development adds a compression ring above the surround and dome (Blue) increasing the tweeters sensitivity above 10kHz. The increased sensitivity helps to flatten the frequency response whilst also reducing the distortion.

The waveguide geometry, has been optimised to work with the new compression ring. Together, this results in reduced distortion across the entire operating band when compared to both Silver 6G & Bronze 6G. **Reduce distortion will mean the speaker are more comfortable to listen to and will go louder.**

New crossover design

At Monitor Audio, designing a crossover starts with designing drivers that complement each other. Early in the development while we are designing the bass, mid and tweeter, we also simulate and design the crossover. This often results in major changes to drivers that is only possible when all the drivers and the crossover are designed by the same company.

The target response for a crossover is an acoustic requirement and doesn't exist in the electrical domain. The crossover components and circuit arrangement should complement the drivers to split the frequency range in a controlled and smooth manner.

In the electrical domain, crossovers can have non-symmetrical designs so long as the acoustic response is shown to be optimised for phase and level in the on and off axis.

The Silver 7G crossovers use a combination of third order filters for all of the tweeter sections with a combination of second and third on the bass and mid-range drivers.

Balancing a simple crossover with the need to perfect the tonal balance is key to the overall performance of the speaker.

Components

Tweeters

- 100V Polypropylene Capacitors
- Air Core wound inductors
- Ceramic Resistors

Midrange

- Combination of 100V Polypropylene Capacitors and 100V Polyester Capacitors arranged to maximise sound quality.
- Combination of laminated steel core and air core inductors arranged to maximise sound quality.
- Ceramic Resistors

Bass

- Large 100V Polyester Capacitors
- Large laminated Steel core inductors
- Ceramic Resistors

New cabinet design and finishes

Silver Series 7G features a contemporary, crisp edged aesthetic, allowing the introduction of two new-real wood veneers: **Natural Walnut** and **Ash**.

Our wooden finishes are real wood veneer, and is seldom found on such competitively priced loudspeakers.

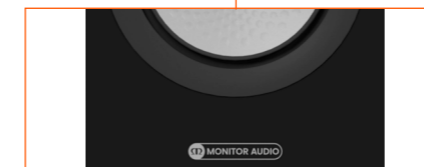

New branding

Silver Series 7G is the first Monitor Audio product to use our new logo and brand identity. This new on-cabinet metallic badge means our brand identity is shown clearly with grille on and off.

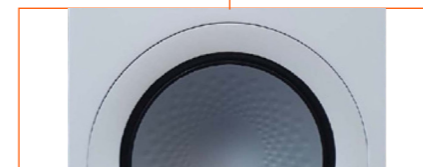

New driver trims

The driver trim rings are painted to match the tweeter trim, giving a balanced visual appearance and less visible rubber driver surround.



New outrigger feet

The new moulded ABS outrigger feet feature spun metal trims, developed for more stability and a new locking foot designed for use with carpeted and hard floors.

Bookshelf with floorstander performance

Both Silver 50 7G and Silver 100 7G have been designed to give a bass extension normally only possible from a floorstanding design.

The Silver 50 7G is optimised towards a low extension when placed close to a wall and is an excellent choice when space is a premium, but sound quality is very important. In-room it extends down to 47Hz.

The Silver 100 7G has a full bass extension similar to a floorstanding speaker, covering the full range of a bass guitar. It also **has the ability to be driven hard and loud, while retaining control and comfort.**



Home cinema solutions

Silver Series 7G features a selection of dedicated home cinema speakers, including a centre channel, surround speakers and Dolby Atmos® enabled upfiring modules.

New Dolby Atmos® enabled speakers

The all new Silver AMS 7G is a Dolby Atmos® certified loudspeaker, designed to fit perfectly on top of the new Silver 300 7G.



A bespoke horn profile and tweeter design specific to the needs of a Dolby Atmos® loudspeaker.

This ensures a tight match to Dolby's requirements and therefore the best performance for your cinema system.

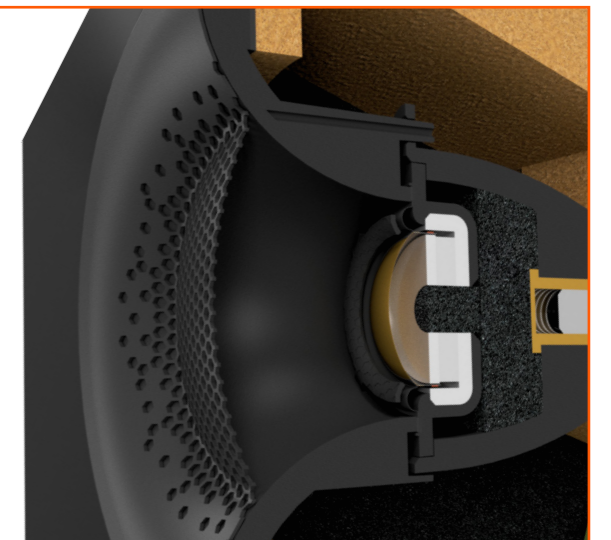

Silver 50 7G



Pair of small Bookshelf / Standmount speakers

- 1 x 1" (25mm) C-CAM Gold Dome tweeter with Uniform Dispersion (UD) Waveguide II for more lifelike sound (Full explanation Page 9)
- 1 x 5 1/4" (134mm) C-CAM mid-bass driver with Rigid Surface Technology (RST) II for extra clarity (Full explanation Page 8)
- Designed to give the bass extension normally only possible from a floorstanding loudspeaker
- Optimised to cope with reflected sound when placed close to a wall
- Excellent choice when space is a premium but sound quality is very important
- Rear-ported and tuned for ease of positioning without affecting sound performance
- Perfect for smaller stereo music set-ups, or as front/rear channels in smaller home cinema systems
- Compact and bookshelf-friendly with rubber stopper feet supplied
- Can be wall-mounted using Monitor Audio FIX-M speaker mount



Silver 100 7G



Pair of large Bookshelf / Standmount speakers

- 1 x 1" (25mm) C-CAM Gold Dome tweeter with Uniform Dispersion (UD) Waveguide II for more lifelike sound (Full explanation Page 9)
- 1 x 8" (203mm) C-CAM mid-bass driver with Rigid Surface Technology (RST) II for extra clarity (Full explanation Page 8)
- Has a full bass extension similar to a floorstanding speaker, covering the full range of a bass guitar
- Excellent choice when space is at a premium but sound quality is very important
- Rear-ported and tuned for ease of positioning without affecting sound performance
- Perfect for smaller stereo music set-ups, or as front/rear channels in smaller home cinema systems
- Bookshelf-friendly with rubber stopper feet supplied



Silver 200 7G



Pair of small floorstanding speakers

- 1 x 1" (25mm) C-CAM Gold Dome tweeter with Uniform Dispersion (UD) Waveguide II for more lifelike sound (Full explanation Page 9)
- 2 x 5 1/4" (134mm) C-CAM mid-bass driver with Rigid Surface Technology (RST) II for extra clarity (Full explanation Page 8)
- 2.5-way design where the top driver is a mid-bass and the bottom is bass only
- Following the proportions of our most successful speakers, the Silver 200 7G has a small footprint that fits very easily into any modern home
- The best of both worlds – size and performance
- Perfect for small to mid-sized room set-ups, either with a stereo or a home cinema system
- Rear-ported and tuned for ease of positioning without affecting sound performance
- Increased stability with sturdy outrigger feet and a choice of spikes for carpets or rubber feet for hard floors



Silver 300 7G



Pair of medium floorstanding speakers

- 1 x 1" (25mm) C-CAM Gold Dome tweeter with Uniform Dispersion (UD) Waveguide II for more lifelike sound (Full explanation Page 9)
- 1 x 3" (76mm) C-CAM mid-range driver with Rigid Surface Technology (RST) II for extra clarity (Full explanation Page 7)
- 2 x 6" (152mm) C-CAM bass driver with RST II for extra clarity (Full explanation Page 8)
- 3-way design with dedicated mid-range and bass drivers to deliver the ultimate refinement
- Perfect for mid to large-sized room set-ups, either stereo or home cinema
- Rear-ported and tuned for ease of positioning without affecting sound performance
- Sturdy outrigger feet with a choice of spikes for carpets or rubber feet for hard floors
- Add Silver AMS 7G Dolby Atmos® enabled speakers for your home cinema system



Silver 500 7G



Pair of large floorstanding speakers

- 1 x 1" (25mm) C-CAM Gold Dome tweeter with Uniform Dispersion (UD) Waveguide II for more lifelike sound (Full explanation Page 9)
- 1 x 3" (76mm) C-CAM mid-range driver with Rigid Surface Technology (RST) II for extra clarity (Full explanation Page 7)
- 2 x 8" (203mm) C-CAM bass driver with RST II for extra clarity (Full explanation Page 8)
- 3-way design with dedicated mid-range and bass drivers to deliver the ultimate refinement
- Silver 500 7G has two 8" drivers and larger volume for more power and bass extension
- Perfect for mid to large-sized room set-ups, either stereo or home cinema
- Rear-ported and tuned for ease of positioning without affecting sound performance
- Sturdy outrigger feet with a choice of spikes for carpets or rubber feet for hard floors



Silver C250 7G



Single centre channel speaker

- 1 x 1" (25mm) C-CAM Gold Dome tweeter with Uniform Dispersion (UD) Waveguide II for more lifelike sound (Full explanation Page 9)
- 1 x 3" (76mm) C-CAM mid-range driver with Rigid Surface Technology (RST) II for extra clarity (Full explanation Page 7)
- 2 x 5 1/4" (134mm) C-CAM bass driver with RST II for extra clarity (Full explanation Page 8)
- Compact full 3-way design offering a wider coverage than traditional two way centre speakers for the best cinema experience in more seating locations
- Perfect for all sizes of home cinema systems
- Combining the best of the small Silver C150 6G and large Silver C350 6G, for high performance with a compact footprint
- Sealed cabinet for precise sound even when installed close to a wall
- Fits easily on shelves or wall units with the rubber stopper feet supplied



Silver FX 7G



Pair of surround / rear speakers

- 2 x 1" (25 mm) C-CAM Gold Dome tweeter with Uniform Dispersion (UD) Waveguide II for more lifelike sound (Full explanation Page 9)
- 1 x 6" (152mm) C-CAM mid-bass driver with Rigid Surface Technology (RST) II for extra clarity (Full explanation Page 8)
- Angled baffles for optimal dispersion
- Discreet design with flush wall placement and recessed terminations
- Dedicated keyhole wall-mounts included for easy installation
- Switchable di-pole/bi-pole configuration especially for home cinema systems
- Sealed cabinet – for accurate performance when installed in restricted voids or close to a wall
- Monitor Audio is one of very few brands making dedicated effects speakers
- Only available in Gloss Black or Satin White finishes



Silver AMS 7G Dolby Atmos® Enabled Speakers



Pair of Dolby Atmos® Enabled Speakers

- 1 x 1" (25 mm) C-CAM Gold Dome tweeter with optimised Waveguide for more lifelike sound (Full explanation Page 9)
- 2 x 5¼" (134mm) C-CAM mid-bass driver with Rigid Surface Technology (RST) II for extra clarity (Full explanation Page 8)
- Dolby Atmos® approved add-on module reflects sound off the ceiling for another dimension of home cinema
- Styled to match and be positioned perfectly on Silver 300 7G speakers for use in any home cinema system
- Can be positioned directly on top of the front and/or rear speakers in a two or four Dolby Atmos® enabled speaker set-up for enhanced atmosphere
- Dedicated keyhole wall-mounts included for easy installation
- With their discreet design, they can be used as separate height surround speakers
- Only available in Gloss Black or Satin White finishes



Silver Series Specifications

Model	Silver 50 7G	Silver 100 7G	Silver 200 7G	Silver 300 7G	Silver 500 7G	Silver C250 7G	Silver FX 7G	Silver AMS 7G
System Format	2-way	2-way	2.5-way	3-way	3-way	3-way	2-way Dipole/Bipole	2-way
Frequency response (-6dB) In room	47 Hz – 35 kHz	35 Hz – 35 kHz	34 Hz – 35 kHz	31 Hz – 35 kHz	27 Hz – 35 kHz	65 Hz – 35 kHz	81 Hz – 35 kHz	76 Hz – 35 kHz
Sensitivity (2.83v @ 1m)	86 dB	87.5 dB	87.5 dB	87.5 dB	90.5 dB	88.5 dB	87.5 dB	87 dB
Nominal impedance	8 Ohms	8 Ohms	8 Ohms	8 Ohms	8 Ohms	8 Ohms	8 Ohms	8 Ohms
Minimum Impedance @ 250 Hz	3.9 Ohms	4.9 Ohms	5.0 Ohms	4.0 Ohms	4.1 Ohms	3.9 Ohms	4.1 Ohms	4 Ohms
Maximum SPL	104 dBA (single)	106 dBA (single)	108 dBA (single)	110 dBA (single)	111 dBA (single)	110 dBA (each)	104 dBA (single)	102 dBA (single)
Power Handling (RMS)	100 W	120 W	150 W	200 W	250 W	200 W	85 W	60 W
Recommended Amplifier Requirements	40 – 100 W	40 – 120 W	60 – 150 W	80 – 200 W	80 – 250 W	80 – 200 W	30 – 85 W	30 – 60 W
Bass Alignment	Bass reflex HiVe II port system	Bass reflex HiVe II port system	Bass reflex Dual HiVe II port system	Bass reflex Dual HiVe II port system	Bass reflex Dual HiVe II port system	Sealed cabinet	Sealed cabinet	Sealed cabinet
Crossover Frequency	2.6 kHz	2.3 kHz	2.7 kHz	750 Hz 2.8 kHz	800 Hz 2.7 kHz	650 Hz 3.3 kHz	2 kHz	2 kHz
Port Tuning Frequency	58Hz	42Hz	49Hz	40Hz	36Hz	N/A	N/A	N/A
Drive Unit Complement	1 x 5 ^{1/4} " C-CAM RST II mid-bass driver 1 x 1" (25 mm) C-CAM Gold Dome tweeter with UD Waveguide II	1 x 8" C-CAM RST II mid-bass driver 1 x 1" (25 mm) C-CAM Gold Dome tweeter with UD Waveguide II	2 x 5 ^{1/4} " C-CAM RST II mid-bass driver 1 x 1" (25 mm) C-CAM Gold Dome tweeter with UD Waveguide II	2 x 6" C-CAM RST II bass driver 1 x 3" C-CAM RST II mid-range driver 1 x 1" (25 mm) C-CAM Gold Dome tweeter with UD Waveguide II	2 x 8" C-CAM RST II bass driver 1 x 3" C-CAM RST II mid-range driver 1 x 1" (25 mm) C-CAM Gold Dome tweeter with UD Waveguide II	2 x 5 ^{1/4} " C-CAM RST II bass driver 1 x 3" C-CAM RST II mid-range driver 1 x 1" (25 mm) C-CAM Gold Dome tweeter with UD Waveguide II	1 x 6" C-CAM RST II mid-bass driver 2 x 1" (25 mm) C-CAM Gold Dome tweeter with UD Waveguide II	1 x 5 ^{1/4} " C-CAM RST II mid-bass driver 1 x 1" (25 mm) C-CAM Gold Dome tweeter with optimised Waveguide*
External Dimensions including Grille and Terminals (H x W x D)	282 x 165 x 272 mm 11 ^{1/8} x 6 ^{1/2} x 10 ^{3/8} "	375 x 230 x 332 mm 14 ^{3/4} x 9 ^{1/16} x 13 ^{5/64} "	885 x 165 x 272 mm 33 ^{13/16} x 6 ^{1/2} x 10 ^{3/8} "	1000 x 185 x 332 mm 39 ^{3/8} x 7 ^{5/16} x 13 ^{5/64} "	1050 x 230 x 332 mm 41 ^{5/16} x 9 ^{1/16} x 13 ^{5/64} "	206 x 481 x 272 mm 8 ^{1/8} x 18 ^{15/64} x 10 ^{45/64} "	250 x 312 x 147 mm 9 ^{13/16} x 13 ^{5/64} x 5 ^{13/16} "	185 x 185 x 313 mm 7 ^{5/16} x 7 ^{5/16} x 12 ^{21/64} "
External Dimensions including Outtrigger Feet and Spikes (H x W x D)	N/A	N/A	930 x 254 x 329 mm 36 ^{39/64} x 10 x 12 ^{61/64} "	1045 x 274 x 389 mm 41 ^{19/64} x 10 ^{25/32} x 15 ^{5/16} "	1095 x 319 x 389 mm 43 ^{7/64} x 12 ^{9/16} x 15 ^{5/16} "	N/A	N/A	N/A
Weight (Each)	5.6 kg 12 lb 6 oz	9.4 kg 20 lb 12 oz	13.7 kg 30 lb 3 oz	19.3 kg 42 lb 9 oz	22.5 kg 49 lb 9 oz	10.6 kg 23 lb 6 oz	4.5 kg 9 lb 15 oz	4.0kg 8 lb 12 oz
Finishes	High Gloss Black, Satin White, Natural Walnut, Ash, Black Oak						High Gloss Black, Satin White	High Gloss Black, Satin White

* Waveguide optimised to comply with Dolby Atmos* directivity targets

Silver Series Drawings

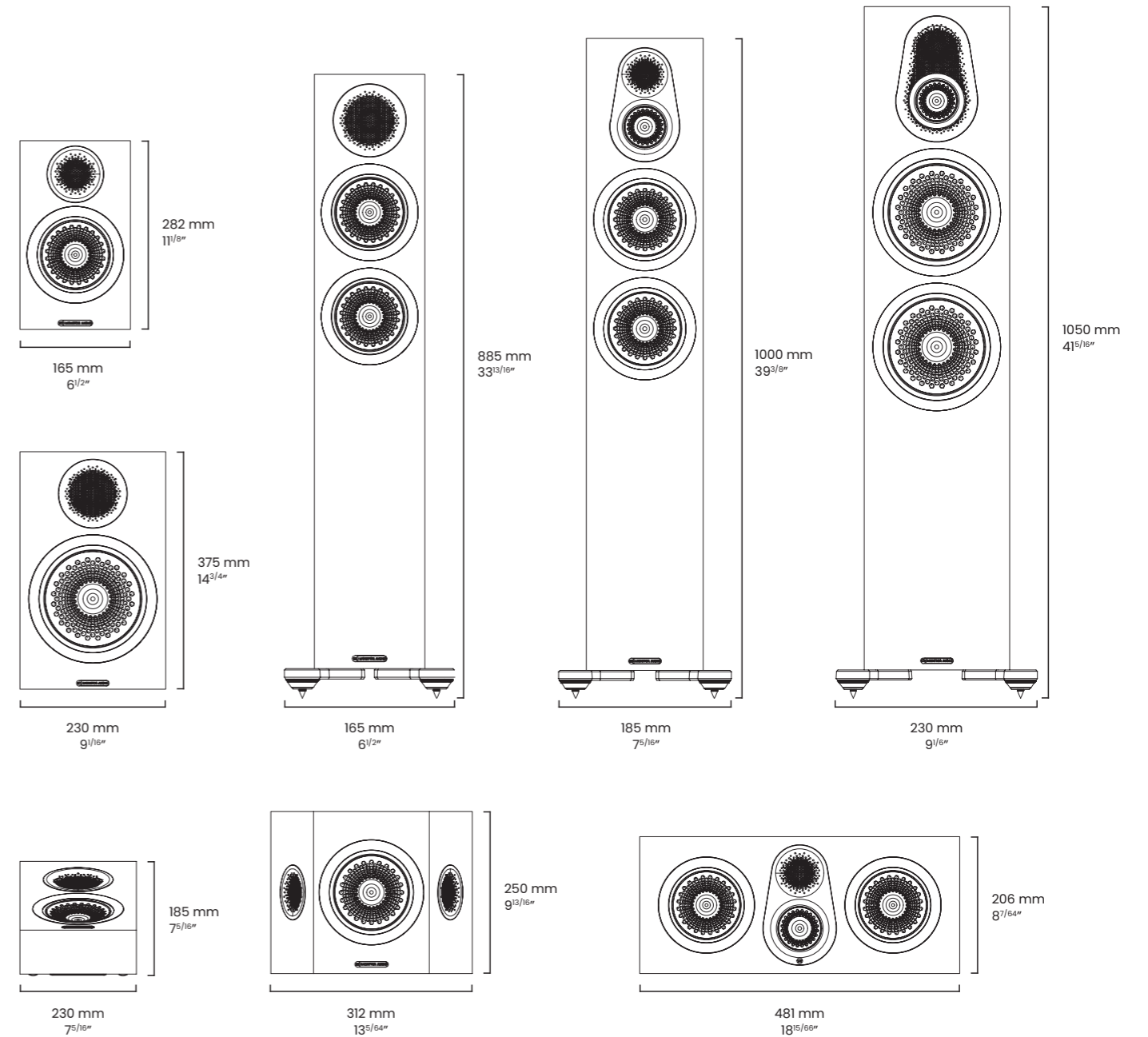

Manufactured under license from Dolby Laboratories.
Dolby, Dolby Atmos, and the double-D symbol are trademarks of Dolby Laboratories.



Monitor Audio Ltd.
24 Brook Road
Rayleigh, Essex
SS6 7XJ
England
Tel: +44 (0)1268 740580
Email: info@monitoraudio.com

[monitoraudio.com](https://www.monitoraudio.com)